



SHOWER DOOR HARDWARE

Create your perfect bathroom with our extensive range of Shower Hardware and accessories.



CRL is the world's largest supplier of Frameless Shower Hardware and Accessories.

Inside this brochure you will find a selection of our bestselling shower door products, ideal for creating the perfect bathroom.

From minimalistic hardware such as Hinges, Clamps, Handles, Door Knobs and U-Channels to complete Sliding Shower Door Kits, CRL offers the full package of quality hardware and accessories that will fit your space.

For more information call FREE on
00 800 0421 6144

CRL
crlaurence.co.uk

Contents

| | |
|-----------------------------------------------------|-----------|
| 01. Hinges and Clamps | 4 |
| Geneva Series | 6 |
| - Junior Geneva Series | 8 |
| - Vienna Series | 9 |
| - Melbourne Series | 10 |
| - Victoria Series | 10 |
| - Clamps for Geneva Series | 11 |
| Pinnacle Series | 12 |
| - Cologne Series | 14 |
| - Plymouth Series | 14 |
| - Clamps for Pinnacle Series | 15 |
| Grande Series | 16 |
| Riviera Series | 18 |
| Altea Series | 20 |
| Oil Dynamic Series | 22 |
| Oil Dynamic Petite Series | 23 |
| Wall Mounted Hinge Profiles | 24 |
| Prima Series | 26 |
| - Senior Prima Series | 28 |
| - Junior Prima Series | 28 |
| - Cardiff Series | 29 |
| - Senior Cardiff Series | 29 |
| Cubicles | 30 |
| 02. Sliding Shower Doors | 32 |
| Serenity | 34 |
| Hydroslide | 36 |
| Compact-X | 38 |
| 03. Support Bar Brackets | 40 |
| Square Support Bars | 42 |
| Round Support Bars | 44 |
| 04. U-Channels & Accessories for Showers | 46 |
| Handles | 48 |
| Knobs | 49 |
| Towel Bars | 50 |
| Door Locks | 52 |
| U-Channels | 53 |
| Shower Seals | 55 |

1



Hinges & Clamps

From the bestselling Geneva Series to luxurious Oil Dynamic Hinges, CRL offers a large range of beautiful hinges to suit your taste and needs.

Our comprehensive Glass Clamps assist in maintaining the frameless appearance of contemporary shower enclosures and provide a clean looking alternative to U-Channels. They also match all our square cornered and bevelled edge hinges for a sleeker appearance.





Geneva Series

Other finishes available as shown in flip out chart at the rear of this brochure

Geneva Series

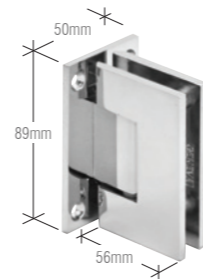

Cat. No. GEN037XX
Wall Mount Full Back Plate
(Factory set for standard closing position)

Cat. No. GEN537XX
5° Pre-Set Model
(Factory set for 5° tighter closure into shower interior)

Cat. No. GEN337XX
Adjustable Wall Mount Full Back Plate

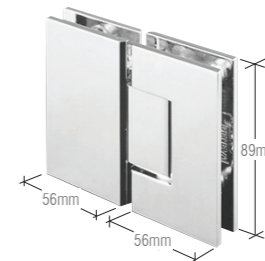

Cat. No. GEN180XX
180° Glass-to-Glass
(Factory set for standard closing position)

Cat. No. GEN580XX
5° Pre-Set Model
(Factory set for 5° tighter closure into shower interior)

Cat. No. GEN380XX
Adjustable 180° Glass-to-Glass



Cat. No. GEN074XX
Wall Mount Short Back Plate
(Factory set for standard closing position)

Cat. No. GEN574XX
5° Pre-Set Model
(Factory set for 5° tighter closure into shower interior)



Cat. No. GEN045XX
135° Glass-to-Glass
(Factory set for standard closing position)

Cat. No. GEN545XX
5° Pre-Set Model
(Factory set for 5° tighter closure into shower interior)

Cat. No. GEN345XX
Adjustable 135° Glass-to-Glass



Cat. No. GEN044XX
Wall Mount Offset Back Plate
(Factory set for standard closing position)

Cat. No. GEN544XX
5° Pre-Set Model
(Factory set for 5° tighter closure into shower interior)

Cat. No. GEN344XX
Adjustable Wall Mount Offset Back Plate



Cat. No. GEN092XX
90° Glass-to-Glass
(Factory set for standard closing position)



Cat. No. GEN90XX
T Configuration Glass-to-Glass



Cat. No. GENGK1
Black Gasket Replacement Kit for Geneva Series

Cat. No. GEN4GKCLR
Clear Gasket Replacement Kit for Geneva Series

Cat. No. GEN13
2.5mm Gaskets for Geneva Hinges using 8mm thick glass

Pivot Pin

See crlaurence.co.uk for more Pivot Pin information

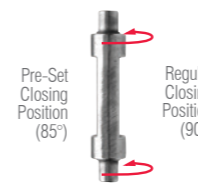

Cat. No. GENP1N

Custom Pivot Pin
Note: Specify angle needed when ordering (up to 45°)

Specifications

Glass Thickness: 8mm to 12mm Toughened Safety Glass

Special Feature: Most models offer a choice of Standard Model, factory set at standard closing position (0°), or 5° Pre-Set Model for tighter closure into shower interior. All models contain a Reversible 5° Pivot Pin. When activated, it allows 5° tighter door closure.

Construction: Solid Brass

Hinge Swings: 90° in and 90° out (at factory set position)

Closing Type: Self-centring when within 15° of closed position

Cut-Out Required (except GEN092 which requires cut-out for door and two holes for fixed panel)

Includes: Gaskets, screws, and glass fabrication dimensions

Standard: EN 1935:2002



| Maximum Capacities | 8mm and 10mm glass | | 12mm glass | |
|--------------------|--------------------|------------|------------|------------|
| | Weight | Door Width | Weight | Door Width |
| Using Two Hinges | 36kg | 711mm | 36kg | 711mm |
| Using Three Hinges | 54kg | 813mm | 54kg | 813mm |

*NOTE: Do not exceed maximum door weight or width when choosing proper quantity of hinges.

Junior Geneva Series

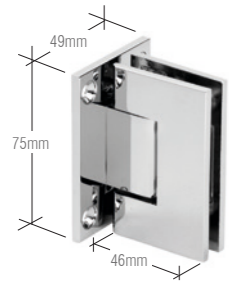

Cat. No. JRG037XX
Wall Mount Full Back Plate
(Factory set for standard closing position)

Cat. No. JRG537XX
5° Pre-Set Model
(Factory set for 5° tighter closure into shower interior)

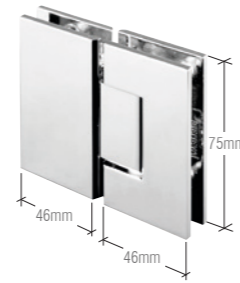

Cat. No. JRG180XX
180° Glass-to-Glass
(Factory set for standard closing position)

Cat. No. JRG580XX
5° Pre-Set Model
(Factory set for 5° tighter closure into shower interior)



Cat. No. JRG074XX
Wall Mount Short Back Plate
(Factory set for standard closing position)

Cat. No. JRG574XX
5° Pre-Set Model
(Factory set for 5° tighter closure into shower interior)



Cat. No. JRG045XX
135° Glass-to-Glass
(Factory set for standard closing position)

Cat. No. JRG545XX
5° Pre-Set Model
(Factory set for 5° tighter closure into shower interior)



Cat. No. JRG044XX
Wall Mount Offset Back Plate
(Factory set for standard closing position)

Cat. No. JRG344CH
Adjustable Wall Mount Offset Back Plate
(Chrome finish only)



Cat. No. JRG092XX
90° Glass-to-Glass
(Factory set for standard closing position)

Pivot Pin
See crlaurence.co.uk for more Pivot Pin information

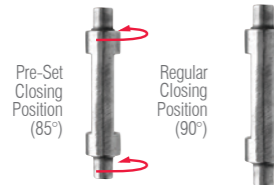

Cat. No. JRGENP1NXX
Custom Pivot Pin
Note: Specify angle needed when ordering (up to 45°)



Cat. No. JRG4GK1
Black Gasket Replacement Kit for Junior Geneva Series

Cat. No. JRG4GKCLR
Clear Gasket Replacement Kit for Junior Geneva Series

Specifications

Glass Thickness: 6mm to 8mm Toughened Safety Glass

Special Features: Most models offer a choice of Standard Model, factory set at standard closing position (0°), or 5° Pre-Set Model for tighter closure into shower interior. All models contain a Reversible 5° Pivot Pin. When activated, it allows 5° tighter door closure.

Construction: Solid Brass

Hinge Swings: 90° in and 90° out

Closing Type: Self-Centring when within 15° of closed position

Cut-Out Required

Includes: Gaskets, screws, and glass fabrication dimensions

Standard: EN 1935:2002



| Maximum Capacities | 6mm glass | | 8mm glass | |
|--------------------|-----------|------------|-----------|------------|
| | Weight | Door Width | Weight | Door Width |
| Using Two Hinges | 28kg | 711mm | 28kg | 711mm |
| Using Three Hinges | 42kg | 813mm | 42kg | 813mm |

*NOTE: Do not exceed maximum door weight or width when choosing proper quantity of hinges.

Vienna Series

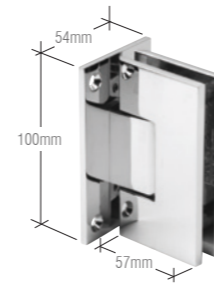

Cat. No. V1E037XX
Wall Mount Full Back Plate
(Factory set for standard closing position)

Cat. No. V1E537XX
5° Pre-Set Model
(Factory set for 5° tighter closure into shower interior)

Cat. No. V1E337XX
Adjustable Wall Mount Full Back Plate

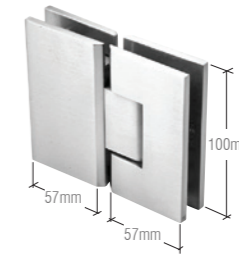

Cat. No. V1E180XX
180° Glass-to-Glass
(Factory set for standard closing position)

Cat. No. V1E580XX
5° Pre-Set Model
(Factory set for 5° tighter closure into shower interior)

Cat. No. V1E380XX
Adjustable 180° Glass-to-Glass



Cat. No. V1E074XX
Wall Mount Short Back Plate
(Factory set for standard closing position)



Cat. No. V1E092XX
90° Glass-to-Glass



Cat. No. V1E044XX
Wall Mount Offset Back Plate
(Factory set for standard closing position)

Cat. No. V1E544XX
5° Pre-Set Model
(Factory set for 5° tighter closure into shower interior)



Cat. No. V1E067XX
Wall mount positive close
(Factory set for standard closing position)



Cat. No. V1E045XX
135° Glass-to-Glass
(Factory set for standard closing position)



Cat. No. V1E780XX
180° Glass-to-Glass Positive Close
(Factory set for standard closing position)

Pivot Pin

See crlaurence.co.uk for more Pivot Pin information

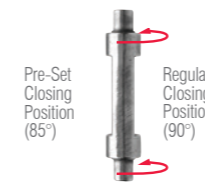

Cat. No. V1EP1N
Custom Pivot Pin

Note: Specify angle needed when ordering (up to 45°)



Cat. No. V1EGK1
Black Gasket Replacement Kit for Vienna Series

Cat. No. V1EGKCLR
Clear Gasket Replacement Kit for Vienna Series

Cat. No. V1E13
2.5mm Gaskets for Vienna Hinges Using 8mm Thick Glass



Specifications

Glass Thickness: 10mm to 12mm Toughened Safety Glass

Special Feature: Most models offer a choice of Standard Model, factory set at standard closing position (0°), or 5° Pre-Set Model for tighter closure into shower interior. All models contain a Reversible 5° Pivot Pin. When activated, it allows 5° tighter door closure.

Construction: Solid Brass

Hinge Swings: 90° in and 90° out

Closing Type: Self-centring when within 15° of closed position

Cut-out required (except V1E092 which requires cut-out for door and two holes for fixed panel)

Includes: Gaskets, screws, and glass fabrication dimensions

Standard: EN 1935:2002

All Vienna hinges, except V1E074, V1E044 and V1E544

| Maximum Capacities | 10mm glass | | 12mm glass | |
|--------------------|------------|------------|------------|------------|
| | Weight | Door Width | Weight | Door Width |
| Using Two Hinges | 50kg | 914mm | 50kg | 914mm |
| Using Three Hinges | 63kg | 914mm | 63kg | 914mm |

*NOTE: Do not exceed maximum door weight or width when choosing proper quantity of hinges.

For V1E074, V1E044 and V1E544

| Maximum Capacities | 10mm glass | | 12mm glass | |
|--------------------|------------|------------|------------|------------|
| | Weight | Door Width | Weight | Door Width |
| Using Two Hinges | 45kg | 864mm | 45kg | 813mm |
| Using Three Hinges | 59kg | 864mm | 59kg | 813mm |

*NOTE: Do not exceed maximum door weight or width when choosing proper quantity of hinges.

Melbourne Series



Cat. No. MEL037XX
Wall Mount Full Back Plate
(Factory set for standard closing position)



Cat. No. MEL024XX
Wall Mount Offset Back Plate with Cover Plate
(Factory set for standard closing position)
Cat. No. MEL324XX
Adjustable Wall Mount Offset Back Plate with Cover Plate
(Factory set for standard closing position)
For replacement cover plates, order MEL024CPXX



Cat. No. MEL180XX
180° Glass-to-Glass
(Factory set for standard closing position)
Cat. No. MEL182CHXX
180° Glass-to-Glass with Cover Plate
(Factory set for standard closing position)
Cat. No. MEL382XX
Adjustable 180° Glass-to-Glass with Cover Plate
(Factory set for standard closing position)
For replacement cover plates, order MEL180CPXX



Cat. No. MEL044XX
Wall Mount Offset Back Plate
(Factory set for standard closing position)



Cat. No. MEL054XX
Face Mount Hinge with Cover Plate
(Factory set for standard closing position)
For replacement cover plates, order MEL180CPXX

NEW GASKET TECHNOLOGY for 8mm to 12mm Glass



| Maximum Capacities | 8mm to 12mm glass | |
|--------------------|-------------------|------------|
| | Weight | Door Width |
| Using Two Hinges | 45kg | 762mm |
| Using Three Hinges | 54kg | 864mm |

*NOTE: Do not exceed maximum door weight or width when choosing proper quantity of hinges.

Specifications

Glass Thickness: 8mm to 12mm Toughened Safety Glass
Construction: Solid Brass
Hinge Swings: 90° in and 90° out (at factory set position)
Closing Type: Self-Centring when within 15° of closed position
Cut-Out Required
Includes: Gaskets, screws, and glass fabrication dimensions

Victoria Series



Cat. No. VCT037XX
Wall Mount Full Back Plate
(Factory set for standard closing position)



Cat. No. VCT180XX
180° Glass-to-Glass
(Factory set for standard closing position)

OUR HEAVY-DUTY HINGES FOR LARGE PANELS UP TO 1,000MM



| Maximum Capacities | 10mm to 12mm glass | |
|--------------------|--------------------|------------|
| | Weight | Door Width |
| Using Two Hinges | 64kg | 1m |

*NOTE: Do not exceed maximum door weight or width when choosing proper quantity of hinges.

Pivot Pin

See crlaurence.co.uk for more Pivot Pin information

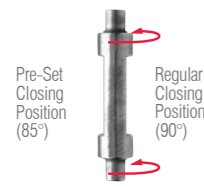

Cat. No. VCTP1N
Custom Pivot Pin
Note: Specify angle needed when ordering (up to 45°)

Specifications

Glass Thickness: 10mm to 12mm Toughened Safety Glass
Construction: Solid Brass
Hinge Swings: 90° in and 90° out (at factory set position)
Closing Type: Self-Centring when within 15° of closed position
Cut-Out Required
Includes: Gaskets, screws, and glass fabrication dimensions

Clamps for Geneva Series



Cat. No. SCU4XX
Square Wall Mount Clamp
(Hole-in-Glass Style)
Cat. No. SCU48CH*
Chrome finish only
Size: 51mm W x 51mm H



Cat. No. SGCU1XX
Square Wall Mount Clamp
(Notch-in-Glass Style)
Size: 51mm W x 51mm H



Cat. No. SGC180XX
Square 180°
Glass-to-Glass Clamp
Size: 127mm W x 51mm H



Cat. No. SGC90XX
Square 90°
Glass-to-Glass Clamp
Each Leg Size:
64mm W x 51mm H



Cat. No. SGC0F90XX
Square 90° Glass-to-Glass
Clamp Open Face
Each Leg Size:
44mm W x 44mm H



Cat. No. SGCU1G
Replacement Gasket
Notch Style
Use this gasket for
8mm glass

Cat. No. SCU4G
Replacement Gasket
Hole Style



Cat. No. SGC037XX
Fixed Panel Square Clamp
(with Small Leg)
Clamp Size:
51mm W x 51mm H
Leg Size:
35mm W x 51mm



Cat. No. SGC186XX
Square Wall Mount Movable
Transom Clamp
Size: 51mm W x 51mm full H



Cat. No. GE090XX*
Glass-to-Glass Bracket
Satin Nickel and
Satin Chrome only
Each Size Leg:
54mm W x 89mm H



Cat. No. SGC039XX
Fixed Panel Square Clamp
(with Large Leg)
Cat. No. SGC0398CH*
Chrome finish only
Clamp Size:
51mm W x 51mm H
Leg Size:
51mm W x 51mm H



Cat. No. SGC188XX
Square 180° Glass-to-Glass
Movable Transom Clamp
Size: 103mm W x 51mm H



Cat. No. GE90SXX*
Wall Mount Bracket
Clamp Size:
54mm W x 89mm H
Leg Size:
49mm W x 89mm H



Cat. No. SGC135XX
Square 135°
Glass-to-Glass Clamp
Each Leg Size:
64mm W x 51mm H

Specifications

Glass Thickness: 10mm to 12mm
(*SCU48CH & SGC0398CH: 8mm only)
(*GE090S & GE90S: 8mm to 12mm glass)

Construction: Solid Brass

Glass Fabrication Required: SGCU1 requires notch; other clamps require holes or hole and notch combination

Includes: Mounting screws and gaskets





Pinnacle Series

Other finishes available as shown in flip out chart at the rear of this brochure

Pinnacle Series



Cat. No. P1N037XX
Wall Mount Full Back Plate
(Factory set for standard closing position)

Cat. No. P1N537XX
5° Pre-Set Model
(Factory set for 5° tighter closure into shower interior)

Cat. No. P1N337XX
Adjustable Wall Mount Full Back Plate

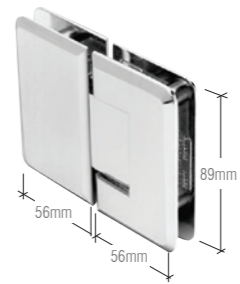

Cat. No. P1N180XX
180° Glass-to-Glass
(Factory set for standard closing position)

Cat. No. P1N580XX
5° Pre-Set Model
(Factory set for 5° tighter closure into shower interior)

Cat. No. P1N380CHXX
Adjustable 180° Glass-to-Glass



Cat. No. P1N074XX
Wall Mount Short Back Plate
(Factory set for standard closing position)

Cat. No. P1N574XX
5° Pre-Set Model
(Factory set for 5° tighter closure into shower interior)



Cat. No. P1N045XX
135° Glass-to-Glass
(Factory set for standard closing position)

Cat. No. P1N345XX
Adjustable 135° Degree Glass-to-Glass



Cat. No. P1N044XX
Wall Mount Offset Back Plate
(Factory set for standard closing position)

Cat. No. P1N544XX
5° Pre-Set Model
(Factory set for 5° tighter closure into shower interior)

Cat. No. P1N344XX
Adjustable Wall Mount Offset Back Plate



Cat. No. P1N092XX
90° Glass-to-Glass
(Factory set for standard closing position)

Pivot Pin
See crlaurence.co.uk
for more Pivot Pin
information

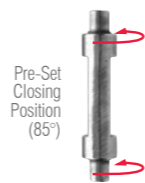

Pre-Set
Closing
Position
(85°)



Regular
Closing
Position
(90°)



Cat. No. GENP1N
Custom Pivot Pin
Note: Specify angle
needed when ordering
(up to 45°)

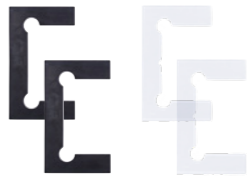

Cat. No. P1NGASK
Black Gasket Replacement Kit for Pinnacle Series

Cat. No. P1NGASKCLR
Clear Gasket Replacement Kit for Pinnacle Series

Cat. No. P1N13
2.5mm Gaskets for Pinnacle Hinges
using 8mm thick glass

Specifications

Glass Thickness: 8mm to 12mm Toughened Safety Glass

Special Feature: Wall Mount Hinges and 180° Glass-to-Glass Hinge offer a choice of a Standard Model, factory set at standard closing position (0°), or a 5° Pre-Set Model for tighter closure into shower interior

Construction: Solid Brass

Hinge Swings: 90° in and 90° out

Closing Type: Self-centring when within 15° of closed position

Cut-Out Required

Includes: Gaskets, screws, and glass fabrication dimensions

Standard: EN 1935:2002

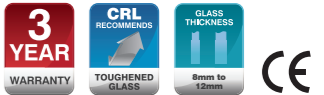

| Maximum Capacities | 8mm and 10mm glass | | 12mm glass | |
|--------------------|--------------------|------------|------------|------------|
| | Weight | Door Width | Weight | Door Width |
| Using Two Hinges | 36kg | 711mm | 36kg | 711mm |
| Using Three Hinges | 54kg | 813mm | 54kg | 813mm |

*NOTE: Do not exceed maximum door weight or width when choosing proper quantity of hinges.

Cologne Series

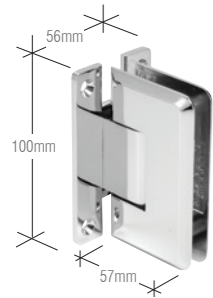

Cat. No. C0L037XX
Wall Mount Full Back Plate
(Factory set for standard closing position)

Cat. No. C0L537XX
5° Pre-Set Model
(Factory set for 5° tighter closure into shower interior)

Cat. No. C0L337XX
Adjustable Wall Mount Full Back Plate

Cat. No. C0L067XX
Wall Mount Positive Close Hinge
(Factory set for standard closing position)

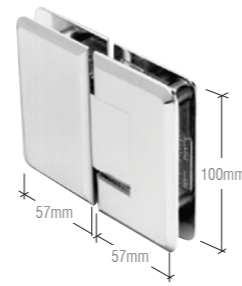

Cat. No. C0L180XX
180° Glass-to-Glass
(Factory set for standard closing position)

Cat. No. C0L380XX
Adjustable 180° Glass-to-Glass

Cat. No. C0L780XX
Glass Positive Close Cologne Hinge
(Factory set for standard closing position)



Cat. No. C0L044XX
Wall Mount Offset Back Plate
(Factory set for standard closing position)

Cat. No. C0L544XX
5° Pre-Set Model
(Factory set for 5° tighter closure into shower interior)



Cat. No. C0L045XX
135° Glass-to-Glass
(Factory set for standard closing position)



Cat. No. C0L092XX
90° Glass-to-Glass
(Factory set for standard closing position)



Cat. No. C0LGK1
Gasket Replacement Kit for Cologne Series

Cat. No. C0L13
2.5mm Gaskets for Cologne Hinges
using 8mm thick glass

For Pivot Pin, see Cat. No. V1EP1N on page 9



Specifications

Glass Thickness: 10mm to 12mm
Toughened Safety Glass

Construction: Solid Brass

Hinge Swings: 90° in and 90° out (at factory setting)

Closing Type: Self-centring when within 15° of closed position

Cut-Out Required

Includes: Gaskets, screws, and glass fabrication dimensions

Standard: EN 1935:2002

| Hinge | Maximum Capacities | 10mm glass | | 12mm glass | |
|-------------------------------------------|--------------------|------------|------------|------------|------------|
| | | Weight | Door Width | Weight | Door Width |
| All Cologne hinges except C0L044 & C0L544 | Using Two Hinges | 50kg | 914mm | 50kg | 914mm |
| | Using Three hinges | 63kg | 914mm | 63kg | 914mm |
| C0L044 & C0L544 | Using Two Hinges | 45kg | 864mm | 45kg | 864mm |
| | Using Three Hinges | 59kg | 864mm | 59kg | 864mm |

NOTE: Do not exceed maximum door weight or width when choosing proper quantity of hinges.

Plymouth Series

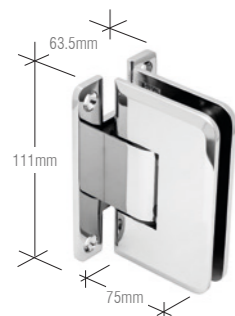

Cat. No. PLY037XX
Wall Mount Full Back Plate
(Factory set for standard closing position)

Specifications

Glass Thickness: 10mm to 12mm Toughened Safety Glass

Construction: Solid Brass

Hinge Swings: 90° in and 90° out (at factory setting)

Closing Type: Self-Centring when within 15° of closed position

Cut-Out Required

Includes: Gaskets, screws and glass fabrication dimensions



OUR HEAVY-DUTY HINGES FOR LARGE PANELS UP TO 1,000MM

| Maximum Capacities | 10mm to 12mm glass | |
|--------------------|--------------------|------------|
| | Weight | Door Width |
| Using Two Hinges | 64kg | 1m |

*NOTE: Do not exceed maximum door weight or width when choosing proper quantity of hinges.



Cat. No. PLY180CH
180° Glass-to-Glass
(Factory set for standard closing position)

Clamps for Pinnacle series



Cat. No. BCU4XX
Square Wall Mount Clamp
(Hole-in-Glass Style)

Cat. No. BCU48CH
For 8mm Glass. Chrome finish only
Size: 51mm W x 51mm H

Glass Thickness Range:
10mm to 12mm



Cat. No. BGC180XX
Square 180° Glass-to-Glass
Clamp

Size: 127mm W x 51mm H
Glass Thickness Range:
10mm to 12mm

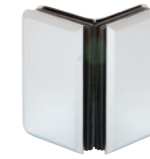

Cat. No. P1090XX
Pinnacle and Prima Series
Glass-to-Glass Bracket

Size: 59mm W x 89mm H
Glass Thickness Range:
8mm to 12mm



Cat. No. BGC135XX
Square 135° Glass-to-Glass
Clamp

Size: 51mm W x 51mm H
Glass Thickness Range:
10mm to 12mm



Cat. No. BGC135XX
Square 135° Glass-to-Glass
Clamp

Each Leg Size:
64mm W x 51mm H
Glass Thickness Range:
10mm to 12mm



Cat. No. P190SXX
Pinnacle and Prima Series Wall
Mount Bracket

Clamp Size: 54mm W x 89mm H
Leg Size: 54mm W x 89mm H
Glass Thickness Range:
8mm to 12mm



Cat. No. BGC037XX
Fixed Panel Square Clamp
(with Small Leg)

Clamp Size: 51mm W x 51mm H
Leg Size: 35mm W x 51mm H
Glass Thickness Range:
10mm to 12mm



Cat. No. BGC90XX
Square 90° Glass-to-Glass
Clamp

Each Leg Size:
64mm W x 51mm H
Glass Thickness Range:
10mm to 12mm



Cat. No. BGC186XX
Replacement Gasket
Notch Style
Use this gasket for 8mm glass



Cat. No. BCU4G
Replacement Gasket
Hole Style



Cat. No. BGC0398CH
Fixed Panel Bevelled Clamp (with
Large Leg) Chrome Finish Only

Cat. No. BGC039XX
Fixed Panel Square Clamp
(with Large Leg)

Clamp Size: 51mm W x 51mm H
Leg Size: 51mm W x 51mm H
Glass Thickness Range:
10mm to 12mm



Cat. No. BGC188XX
Square Wall Mount
Movable Transom Clamp

Size: 51mm W x 51mm H
Glass Thickness Range:
10mm to 12mm



Cat. No. BGC188XX
Square 180° Glass-to-Glass
Movable Transom Clamp

Size: 103mm W x 51mm H

Radius Corner Clamps



Cat. No. UC77XX
Traditional Style Fixed Panel U-Clamp

Size: 44mm W x 44mm H
Glass Thickness Range:
8mm to 10mm

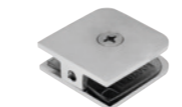

Cat. No. UC79XX
Oversized Fixed Panel U-Clamp

Size: 49mm W x 44mm H
Glass Thickness Range:
8mm to 12mm

Includes: Mounting Screws (for
Wall Clamps) and Clear Gasket
*An additional set of clear
gaskets (Cat. No. UCG77) is
required for 8mm glass.

Hole Diameter Required: 16 or 19mm



Cat. No. GCB184XX
180 Degree Traditional Style
Double Stud Glass-to-Glass
Clamp

Size: 89mm W x 44mm H
Glass Thickness Range:
8mm to 12mm

Hole Diameter Required:
16 or 19mm

Includes: Gaskets
*An additional set of gaskets
is required for 8mm glass
(Cat. No. GCBG184).



Cat. No. ADJ037XX
Adjustable Wall Mount Clamp

Size: 49mm W x 44mm H

Glass Thickness Range:
8mm to 12mm

Hole Diameter Required: 22mm

Includes: Clear Gaskets and
Mounting Screw



Cat. No. GCB182XX
180 Degree Traditional Style Split
Face and "Y" Inline Glass-to-Glass
Clamp

Size: 89mm W x 44mm H
Glass Thickness Range:
8mm to 12mm

Hole Diameter Required:
16 or 19mm

Includes: Gaskets, Screw for
"Y" Inline Clamp use
*An additional set of gaskets
is required for 8mm glass
(Cat. No. UCG77).



Cat. No. GCB90XX
90° Traditional Style
Glass-to-Glass Clamp

Size: 44mm W x 44mm H
Glass Thickness Range:
8mm to 10mm

Cat. No. GCB91XX
Oversized Glass-to-Glass
Clamp

Size: 49mm W x 44mm H

Glass Thickness Range:
8mm to 12mm
Hole Diameter Required:
16 or 19mm

Includes: Gaskets and
Wood Screw for wall mount
application.
*An additional
set of gaskets is required for
8mm glass (Cat. No. UCG77)



Cat. No. ADJ180XX
Adjustable Glass-to-Glass Mount
Clamp

Size: 49mm W (each leg) x
44mm H

Glass Thickness Range:
8mm to 12mm

Hole Diameter Required: 22mm

Includes: Clear Gaskets
and Mounting Screw



Grande Series

Other finishes available as shown in flip out chart at the rear of this brochure

Grande Series

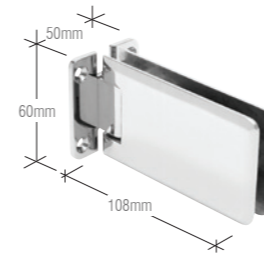

Cat. No. GRA037
Wall Mount Full Back Plate

Cat. No. GRA337
Adjustable Wall Mount Full Back Plate

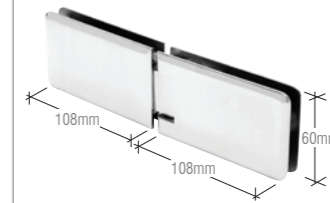

Cat. No. GRA180
180° Glass-to-Glass

Cat. No. GRA380XX
Adjustable 180° Degree Glass-to-Glass



Cat. No. GRA044
Wall Mount Offset Back Plate

Cat. No. GRA344
Wall Mount Offset Back Plate



at. No. GRA135XX
15° Glass-to-Glass



Cat. No. GRA090
90° Glass-to-Glass

Cat. No. GRA390
Adjustable 90° Glass-to-Glass

Specifications

Glass Thickness: 8mm to 10mm Toughened Safety Glass

Special Features: Grande can be side mounted at top and bottom corners of the door, or anywhere in between. Corner mounting allows more glass exposure

Construction: Solid Brass

Hinge Swings: 90° in and 90° out

Closing Type: Precise closing to 0°

Cut-Out and Hole Required

Includes: Gaskets, screws, and glass fabrication dimensions



| Maximum Capacities | 8mm glass | | 10mm glass | |
|--------------------|-----------|------------|------------|------------|
| | Weight | Door Width | Weight | Door Width |
| Using Two Hinges | 41kg | 787mm | 41kg | 787mm |
| Using Three Hinges | 61kg | 864mm | 61kg | 864mm |

*NOTE: Do not exceed maximum door weight or width when choosing proper quantity of hinges.

see page 15 for matching clamps



Riviera Series



Cat. No. R1V044LXX
Left Hand Offset Back Plate
Cat. No. R1V044RXX
Right Hand Offset back Plate



Cat. No. R1V180LNXX
Left Hand 180° Glass-to-Glass
Cat. No. R1V180RNXX
Right Hand 180° Glass-to-Glass



Cat. No. R1V90XX
Fixed Panel Clamp



Cat. No. R1VSCREWSET
Setting Screw Set

Front View



Rear View



FLUSH SCREWS

Specifications

Glass Thickness: 8mm to 10mm Toughened Safety Glass

Construction: Solid Brass

Hinge Swings: Outwards only

Closing Type: Self closes from approximately 60°

Countersunk Holes Required

Includes: Gaskets, screws and flush mount glass attachments.

Finishes Available: Chrome and Brushed Nickel



| Maximum Capacities | 8mm glass | | 10mm glass | |
|--------------------|-----------|------------|------------|------------|
| | Weight | Door Width | Weight | Door Width |
| Using Two Hinges | 41kg | 914mm | 41kg | 762mm |

*NOTE: Do not exceed maximum door weight or width when choosing proper quantity of hinges.



Altea Series

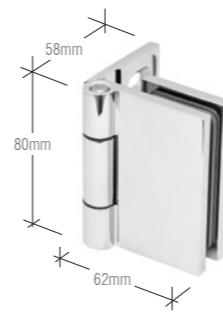

Cat. No. ALT037CH
Wall Mount Full Back Plate



Cat. No. ALT180CH
180° Glass-to-Glass



Cat. No. ALT135CH
135° Glass-to-Glass



Cat. No. ALT092CH
90° Glass-to-Glass



Cat. No. ALTC0VSCH
Small Cover Plate
Cat. No. ALTC0VLCH
Large Cover Plate

SPECIAL FEATURE COVER PLATE SERIES

Specifications

Glass Thickness: 6mm to 10mm
Toughened Safety Glass

Construction: Solid Brass

Hinge Swings: Free swinging design

Closing Type: Self closes from approximately 60°

Cut-Out Required

Includes: Gaskets, screws and screw covers

Finishes Available: Chrome

Hinges

Clamps



Cat. No. ALTCL90CH
Large Glass-to-Wall Clamp



Cat. No. ALTC90CH
90° Glass-to-Wall Clamp



Cat. No. ALTC380CH
Adjustable Glass-to-Glass Clamp



Cat. No. ALTC337CH
Adjustable Glass-to-Wall Clamp



Cat. No. ALTCL180CH
180° Glass-to-Glass Clamp



| Maximum Capacities | 6mm to 10mm glass | |
|--------------------|-------------------|------------|
| | Weight | Door Width |
| Using Two Hinges | 36kg | 710mm |
| Using Three Hinges | 54kg | 810mm |

*NOTE: Do not exceed maximum door weight or width when choosing proper quantity of hinges.



Oil Dynamic Series



Oil Dynamic Petite Series

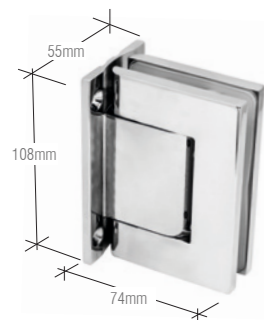

Cat. No. H8010BTXX
Wall Mount Full Back Plate



Cat. No. H8011BTXX
Wall Mount Offset Back Plate

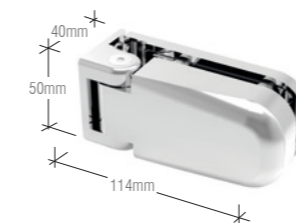

Cat. No. H815E10CH
Wall Mount



Cat. No. H815E50CH
180° Glass-to-Glass



Cat. No. H8015BTXX
180° Glass-to-Glass



Cat. No. H8060BTXX*
Wall Mount Rebated Hinge



| Maximum Capacities | 8mm to 13.52mm glass | |
|-----------------------|----------------------|------------|
| | Weight | Door Width |
| Wall Mount Hinges | 100kg | 1m |
| Glass-to-Glass Hinges | 80kg | 1m |

*NOTE: Do not exceed maximum door weight or width when choosing proper quantity of hinges.

see page 11 for matching clamps

Specifications

Glass Thickness: 8mm to 13.52mm
(*H8060BT 8mm to 12mm) Toughened Safety Glass

Construction: Aluminium

Hinge Swings: 90° inward & outward (except H8060BT model which only swings one way)

Closing Type: Automatic closing from 80° to 0°

Cut-Out Required

Includes: Snap-In moulded gaskets for 8mm to 13.52mm glass and hex screws

Finishes Available: Chrome, Satin Anodised and Satin Nickel

Specifications

Glass Thickness Range:
6mm to 10mm Toughened Safety Glass

Construction: Aluminium

Hinge Swings: Swings one way only

Closing Type: Automatic closing from 80° to 0°

Cut-Out Required

Includes: Gaskets

Finish Available: Chrome



| Maximum Capacities | 6mm to 10mm glass | |
|--------------------|-------------------|------------|
| | Weight | Door Width |
| Using Two Hinges | 50kg | 900mm |

*NOTE: Do not exceed maximum door weight or width when choosing proper quantity of hinges.



Wall Mounted Hinge Profiles

Wall Mounted Hinge Profiles

Cat. No. WHP6CXX
Classic Wall Mounted Hinge Profile for 6mm Toughened Glass

Cat. No. WHP8CXX
Classic Wall Mounted Hinge Profile for 8mm Toughened Glass

Cat. No. WHP6EXX
Expander Wall Mounted Hinge Profile for 6mm Toughened Glass

Cat. No. WHP8EXX
Expander Wall Mounted Hinge Profile for 8mm Toughened Glass



Specifications

Glass Thickness: 6mm to 8mm Toughened Safety Glass
Construction: Aluminium
Hinge Swings: 90° in and 90° out (at factory set position)
Closing Type: Rise and fall action
Includes: 2200mm length hinge profile.
Finishes Available: Bright Anodised and Satin Anodised

| Maximum Capacities | 6mm to 8mm glass | |
|--------------------|------------------|------------|
| | Weight | Door Width |
| | 36kg | 900mm |

*NOTE: Do not exceed maximum door weight or width when choosing proper quantity of hinges.

STANDARD HINGE KITS
For 8mm to 10mm Toughened Safety Glass.

Cat. No. GEN03372XX
1.83m High Geneva Series Kit

Cat. No. GEN03378XX
1.98m High Geneva Series Kit

Cat. No. P1N03372XX
1.83m High Pinnacle Series Kit

Cat. No. P1N03378XX
1.98m High Pinnacle Series Kit

HEAVY DUTY HINGE KITS
For 10mm to 12mm Toughened Safety Glass.

Cat. No. V1E03372XX
1.83m High Pinnacle Series Kit



Specifications

Glass Thickness: 8mm to 12mm Toughened Safety Glass
Construction: Solid brass hinge/Aluminium jamb
Hinge Swings: 90° outwards only
Closing Type: Self-centring when within 15° of closed position
Cut-Out Required
Includes: Gaskets, screws, aluminium closing jamb and bottom seal for 10mm glass.

| Maximum Capacities | 8mm to 10mm | | 10mm | | 12mm | |
|--------------------|-------------|-------|--------|-------|--------|-------|
| | Weight | Width | Weight | Width | Weight | Width |
| GEN / P1N | 36kg | 711mm | | | | |
| V1E | | | 45kg | 762mm | 45kg | 914mm |

*NOTE: Do not exceed maximum door weight or width when choosing proper quantity of hinges.



Prima Series

Other finishes available as shown in flip out chart at the rear of this brochure

Prima Series

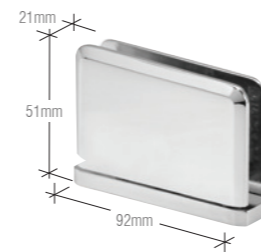

Cat. No. PPH01XX
Top or Bottom Mount
Can be adapted to Deluxe Header Kit

Cat. No. PPH301XX
Adjustable Top or Bottom Mount



Cat. No. PPH03XX
L-Bracket Wall Mount



Cat. No. PPH06XX
Top Mount
Compatible only with EZ-Adjust Header.
Use Cat. No. PPH01 as bottom hinge



Cat. No. PPH05LXX
Offset Bracket Wall Mount
Left Hand Mount when viewed from outside of shower

Cat. No. PPH05RXX
Offset Bracket Wall Mount
Right Hand Mount when viewed from outside of shower

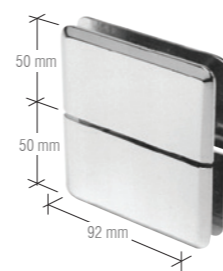

Cat. No. PPH02XX
Glass-to-Glass Transom Mount



Cat. No. PPH135RXX
135° Glass-to-Glass
Right Hand Mount when viewed from outside of shower

Cat. No. PPH135LXX
135° Glass-to-Glass
Left Hand Mount when viewed from outside of shower



Cat. No. PPH07XX
Top or Bottom Mount Pivot Hinge
with Attached U-Clamp



Cat. No. PPH0151XX
5° Pre-Set Series
#1 Pin Top or Bottom Mount

Cat. No. PPH0152XX
5° Pre-Set Series
#2 Pin Top or Bottom Mount



Cat. No. PPHGK
Black Gasket Replacement Kit for Prima Series

Cat. No. PPHGKCLR
Clear Gasket Replacement Kit for Prima Series

Specifications

Glass Thickness: 8mm to 10mm Toughened Safety Glass

Special Feature: Top and Bottom Mount design allows more glass to show. Use of these hinges reduce quantity of cut-outs required when compared to standard side mount glass-to-glass hinges. Cat. No. PPH01 can be mounted floor and ceiling, or floor and header

Construction: Solid Brass

Hinge Swings: Full Rotation

Closing Type: Self-centring when within 15° of closed position

Cut-Out Required

Includes: Gaskets, Screws, and Glass Fabrication Dimensions

This hinge series is patented (Patent Number 5297313)



| Maximum Capacities | 8mm glass | | 10mm glass | |
|--------------------|-----------|------------|------------|------------|
| | Weight | Door Width | Weight | Door Width |
| Using Two Hinges | 45kg | 787mm | 45kg | 787mm |

*NOTE: Do not exceed maximum door weight or width.

see page 15 for matching clamps

Senior Prima Series

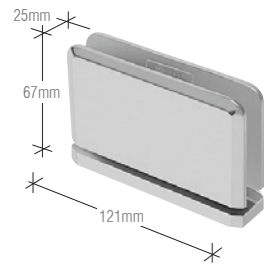

Cat. No. SRPPH01XX
Top or Bottom Mount

For 12mm glass

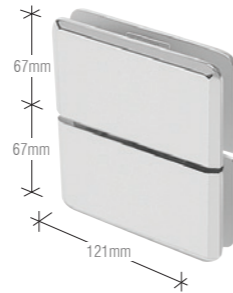

Cat. No. SRPPH02XX
Glass-to-Glass Transom Mount

For 12mm glass



Cat. No. SRPPHGK
Black Gasket Replacement Kit for Senior Prima Series

Cat. No. SRPPHGKCLR
Clear Gasket Replacement Kit for Senior Prima Series

Specifications:

Glass Thickness: 12mm Toughened Safety Glass

Junior Prima Special Feature: Top and bottom mount allows more glass exposure. Can also save on glass fabrication costs when compared to use of Side Mount Glass-to-Glass Hinges requiring more cut-outs.

Construction: Solid Brass

Hinge Swings: Full Rotation

Closing Type: Self-centring when within 15° of closed position

Cut-Out Required

Includes: Gaskets, Screws, and Glass Fabrication Dimensions. Adjustable Prima also includes 3mm Allen Wrench.



| Maximum Capacities | 12mm glass | |
|--------------------|------------|------------|
| | Weight | Door Width |
| Using Two Hinges | 66kg | 914mm |

*NOTE: Do not exceed maximum door weight or width.

Junior Prima Series

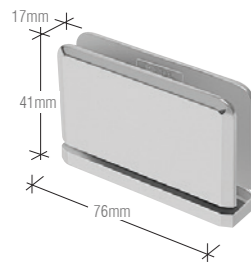

Cat. No. JRPPH01XX
Top or Bottom Mount

For 6mm glass

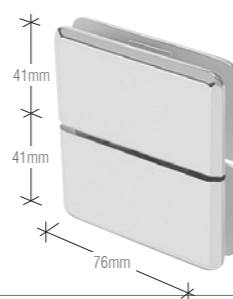

Cat. No. JRPPH02XX
Glass-to-Glass Transom Mount

For 6mm glass



Cat. No. JRPPHGK
Black Gasket Replacement Kit for Junior Prima Series

Specifications:

Glass Thickness: 6mm Toughened Safety Glass

Junior Prima Special Feature: Top and bottom mount allows more glass exposure. Can also save on glass fabrication costs when compared to use of Side Mount Glass-to-Glass Hinges requiring more cut-outs.

Construction: Solid Brass

Hinge Swings: Full Rotation

Closing Type: Self-centring when within 15° of closed position

Cut-Out Required

Includes: Gaskets, Screws, and Glass Fabrication Dimensions. Adjustable Prima also includes 3mm Allen Wrench.



| Maximum Capacities | 6mm glass | |
|--------------------|-----------|------------|
| | Weight | Door Width |
| Using Two Hinges | 28kg | 711mm |

*NOTE: Do not exceed maximum door weight or width.

see page 15 for matching clamps

Cardiff Series

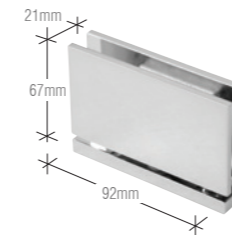

Cat. No. CAR01XX
Top or Bottom Mount

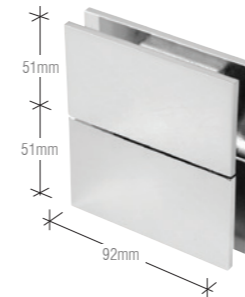

Cat. No. CAR02XX
Glass-to-Glass Transom Mount

Specifications:

Glass Thickness: 8mm to 10mm Toughened Safety

Special Features: Top and Bottom Mount design allows more glass to show. Use of these hinges will reduce quantity of cut-outs required when compared to standard side mount glass-to-glass hinges.

Cat. No. CAR01 can be mounted floor and ceiling, or floor and header.

Construction: Solid Brass

Hinge Swings: Full Rotation

Closing Type: Self-Centering when within 15° of closed position

Cut-Out Required

Includes: Gaskets, screws, and glass fabrication dimensions

This hinge series is patented (Patent Number 5297313)



| Maximum Capacities | 8mm to 10mm glass | |
|--------------------|-------------------|------------|
| | Weight | Door Width |
| Using Two Hinges | 45kg | 787mm |

*NOTE: Do not exceed maximum door weight or width.

Senior Cardiff Series

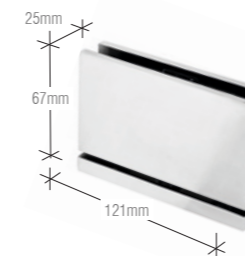

Cat. No. SRCAR01XX
Top or Bottom Mount

Specifications:

Glass Thickness: 12mm Toughened Safety Glass

Special Features: Top and Bottom Mount design allows more glass to show. Use of these hinges will reduce quantity of cut-outs required when compared to standard side mount glass-to-glass hinges.

Cat. No. CAR01 can be mounted floor and ceiling, or floor and header.

Construction: Solid Brass

Hinge Swings: Full Rotation

Closing Type: Self-Centering when within 15° of closed position

Cut-Out Required

Includes: Gaskets, screws, and glass fabrication dimensions

This hinge series is patented (Patent Number 5297313)



| Maximum Capacities | 12mm glass | |
|--------------------|------------|------------|
| | Weight | Door Width |
| Using Two Hinges | 66kg | 914mm |

*NOTE: Do not exceed maximum door weight or width.

see page 11 for matching clamps



Cubicle Components



Cat. No. 31P550GSS
Adjustable Foot

- Stainless steel AISI 316L
- Fixed to the floor by means of the rose
- Height variable from 135 mm to 165 mm
- Not necessary to drill the glass.



Cat. No. 31P554CGSS
180 Degree Glass-to-Glass Gate Hinge

- Stainless steel AISI 316L
- Brushed Stainless Steel Finish
- Recommended for Toughened Laminated Glas



Cat. No. 31P551GSS
Upper Panel Holder

- Stainless steel AISI 316L
- Slipped on the upper rail tube
- Not necessary to drill the glass



Cat. No. 31P555GSS
Wall Fixing Rose

- Stainless steel AISI 316L
- Expanding plug for connection to the tube



Cat. No. 31P552AGSS
Wall Angle Bracket Fixing Kit

- Stainless steel AISI 316L
- Fix the angle bracket between glass-wall



Cat. No. 31P555SGSS
Adjustable Wall Fixing Rose

- Stainless steel AISI 316L
- Central pin allowing the recovery of the wall faults

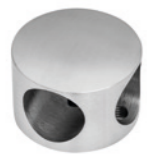

Cat. No. 31P561GSS
Upper Rail T-Joint

- Stainless steel AISI 303
- Allows the quick T- junction of two tubes

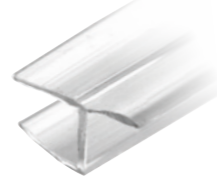

Cat. No. PCC10
"H" Jamb With Soft Leg

- Length: 2.49m
- Soft vinyl single leg for quieter door closure
- Snaps onto fixed panel
- For glass-to-glass applications
- Suggested gap: 4.7mm



Cat. No. 31P552BGSS
Angle Bracket Fixing Kit

- Stainless steel AISI 316L
- Fix the angle bracket with L- junction between glass-glass.



Cat. No. 31P558GSS
Snib Indicator Lock

- Stainless steel AISI 316L and stainless steel AISI 303.
- Rotating handle that in closing position is set in a locking device
- External side is equipped with a vacant/engaged indicator.



Cat. No. 31P562GSS
Robe Hook / Stop

- Stainless steel AISI 316L
- With rubber doorstop

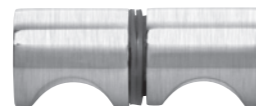

Cat. No. SDK140BN
Back-to-Back E-Z Grip Style

- Glass Thickness: 6mm to 12mm
- Hole Diameter Required: 12mm



Cat. No. 31P552CGSS
T-Section Fixing Kit

- It consists of turned articles and screws in stainless steel AISI 316L to fix the angle bracket with T- junction between glass-glass.



Cat. No. 31P556GSS
90° Upper Joint Rail Bracket

- Stainless steel AISI 303
- Allows the quick junction at 90° of two tubes.



Cat. No. 31P563GSS
Tube Connector For 31P560GSS

- Constructed from two die-cast expanding plugs
- Threaded rod in galvanised steel and a centring ring.

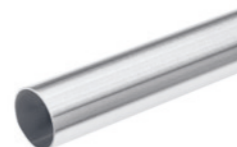

Cat. No. 31P560GSS
Upper Rail Tube

- Stainless steel AISI 316L
- Available in 3 meter length tubes



Cat. No. 31P552GSS
90° Angle Bracket

- Stainless steel AISI 316L
- Fix two panels together or to fix the panel to the wall
- Allows adjusting tolerances between wall and panel

2

Sliding Shower Doors

CRL's latest Sliding Shower Door Systems provide frameless hardware which gives a sleek and minimalistic appearance.

Our Sliding Shower Door Systems are available in several lengths and finishes and can accommodate a wide range of shower designs.





Serenity

Cat. No. SER78XX
Deluxe 180° Serenity Kit for 8mm to 10mm Glass

Cat. No. SRSER78XX
Senior 180° Serenity Kit for 12mm Glass

Standard 180 Degree Kit Includes:
1 - 2m length header support bar
4 - Rollers
1 - Stopper
2 - Track holder fittings for wall
1 - Thru-glass pull
1 - Door guide



| | |
|--------------------------------------------------------------------------------------------------------------------------------------------------------------------------------------------------------------------|--------------------------------------------------------------------------------------------------------------------------------------------------------------------------------|
|  <p>Cat. No. SER90XX Accessory kit for 90 degree return Connects to wall fitting for 90 degree installations</p> |  <p>Cat. No. SERAHW2XX Track Holder Fittings for Wall</p> |
|  <p>Cat. No. SERH2XX Serenity Series Sliding Door 2m Header Support Bar Only</p> |  <p>Cat. No. SERFP2XX Track Holder Fittings for Fixed Panel - 2/Pk</p> |
|  <p>Cat. No. SERNR1XX New Style Replacement Roller for SER78BS</p> |  <p>Cat. No. SERNG2XX Replacement Door Guide for Fixed Panel Attachment</p> |
|  <p>Cat. No. SERNS1XX Replacement Door Stopper for SER78BS</p> |  <p>Cat. No. DK98L Replacement Clear Plastic L-Shaped Vinyl</p> |
|  <p>Cat. No. SERNHP2XX Thru-Glass Pull</p> |  <p>Cat. No. SERC2XX 90 Degree Door Connector Bracket for Serenity Sliders</p> |
|  <p>Cat. No. SERP2XX Thru-Glass Pull</p> | |

Specifications:

Glass Thickness: 8mm to 10mm Toughened Safety Glass

Construction: Stainless Steel

Glass Fabrication Required: Holes required in both door & fixed panel

Includes: Gaskets, screws & glass fabrication information. Complete installation instructions, along with glass & metal cutting formula available at crlaurence.co.uk

Finishes Available: Polished or Brushed Stainless Steel



| | | |
|---------------------------|-------------|------------|
| Maximum Capacities | 8mm to 10mm | |
| | Weight | Door Width |
| | 40kg | 762mm |

*NOTE: Do not exceed maximum door weight or width.



Hydroslide

Hydroslide

Standard 180 Degree Kit Includes:

- 1 - Sliding glass door upper track
- 2 - Hangers for sliding glass door
- 2 - Sliding glass door rollers
- 2 - Sliding glass door roller stops
- 1 - Sliding glass door floor guide
- 2 - 90 degree wall-to-upper track connectors
- 2 - 180 degree glass-to-sliding track connectors
- 1 - 914mm half-round sdt980 threshold
- 1 - 2489mm DK98L L-seal for wall

NOTE: Bottom fixed glass attachments, handles or knobs must be ordered separately.



Cat. No. HYDK60XX
1.52m 180° Kit

Cat. No. HYDK84XX
2.13m 180° Kit



Cat. No. HYD60XX
1524mm Upper Track

Cat. No. HYD84XX
2134mm Upper Track



Cat. No. HYD03XX
Kit Consists Of One Floor Guide And Two Screws



Cat. No. HYDA90XX
90° Wall-to-Glass Accessory Kit



Cat. No. HYD180XX
180° Wall-to-Upper Track Connector



Cat. No. HYD01XX
Kit Consists Of Two Rollers, Two Glass Hangers And Two Snap-In Screw Covers



Cat. No. HYDG90XX
90° Glass-to-Sliding Track Connector



Cat. No. HYD02
Black
Kit Consists Of Two Roller Stops With Screws.



Cat. No. HYDW90XX
90° Wall-to-Upper Track Connector



Cat. No. HYD04XX
Kit Consists Of Two Snap-In Screw Covers



Cat. No. HYD05XX
Wall Clamp Securing A Glass Panel At 90° To The Wall. Includes Two Screws And Snap-In Screw Covers

Specifications:

Glass Thickness: 8mm to 10mm Toughened Safety Glass

Construction: Plated or Lacquered Solid Brass Fittings; Anodized Aluminum Sliding Door Track

Maximum Door Weight: 40kg

Fabrication: Holes required in fixed panel and door

Includes: Gaskets, screws, and glass fabrication information. Complete installation instructions, along with glass and metal cutting formula, available at crlaurence.co.uk

Finishes Available: Chrome and Brushed Nickel



Cat. No. HYDH90
90° Hydroslide Header Bracket



Compact-X

Compact-X Sliding Door System

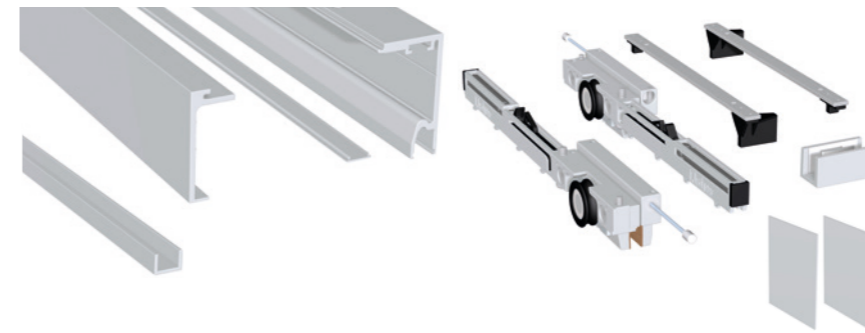

Cat. No. EUCRLX3FXX
3m Kit with Double Softbrake - Ceiling Mount with Fixed Panel



Cat. No. EUCRLXSBKITXX
Fitting Set with Double Softbrake



Cat. No. EUCRLXGFKITXX
Glass Wall Mount Point Fixing Kit

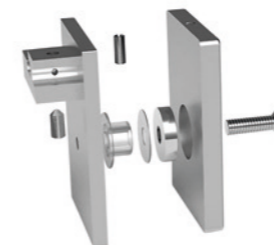

Cat. No. EUCRLX90XX
90° Through Glass Return Bracket



Cat. No. EUCRLXWB
Wall Fixing 'L' Bracket



Specifications:

Glass Thickness: 8mm to 10mm Toughened Safety Glass

Construction: Aluminium

| Maximum Capacities | Weight | Minimum Width |
|--------------------|--------|---------------|
| | 70kg | 635mm |

*NOTE: Do not exceed maximum door weight or width when choosing proper quantity of hinges.

3

Support Bars & Brackets

CRL's wide range of support Bars and Brackets come in a variety of lengths and finishes. It is available in square and round styles and suitable for a range of glass thicknesses

Sold as individual components or complete kits, the range offers an endless choice of configurations to help you create your perfect bathroom.



Square Support Bar Series - 19 x 19 mm



Cat. No. SQ39XX
Length: 1m
Cat. No. SQ59XX
Length: 1.5m



Cat. No. SQ47XX
45° Mitered Wall Mount Bracket



Cat. No. SQ41XX
Swiveling U-Bracket
For 6mm to 8mm Glass
Cat. No. SQ42XX
Swiveling U-Bracket
For 10mm to 12mm Glass



Cat. No. SQ48XX
22.5° Mitered Wall Mount Bracket



Cat. No. SQ43XX
Movable Bracket
For 6mm to 8mm Glass
Cat. No. SQ44XX
Movable Bracket
For 10mm to 12mm Glass



Cat. No. SQ49XX
Adjustable Wall Mount Bracket



Cat. No. SQ45XX
Adjustable Corner Bracket



Cat. No. SQ50XX
"T" Junction Bracket



Cat. No. SQ46XX
Wall Mount Bracket



Cat. No. SQ9XX
Cornered Bracket
For 6mm to 8mm Glass

Cat. No. SQ910XX
Cornered Bracket
For 10mm to 12mm Glass

Specifications:

Glass Thickness: 6mm to 8mm, and 10mm to 12mm glass

Construction: 19mm square tubing, solid brass fittings

Includes: All required mounting hardware



Other finishes available as shown in flip out chart at the rear of this brochure

Slimline Support Bar Series - 15 x 15 mm



Cat. No. SQJ39XX
Length: 1m
Cat. No. SQJ80XX
Length: 2m



Cat. No. SQJ41XX
Swiveling U-Bracket



Cat. No. SQJ50XX
T Junction Bracket



Cat. No. SQJ43XX
Movable U-Bracket



Cat. No. SQJ41DXX
Swiveling Flush Mounted U-Bracket



Cat. No. SQJ49XX
Adjustable Wall Mount Bracket



Cat. No. SQJ46XX
Wall Mount Bracket

Specifications:

Glass Thickness: 6mm to 8mm glass

Construction: 15mm slimline square tubing, solid brass fittings

Includes: All required mounting hardware



Deluxe Shower Door Header Kit



SQH Series

Cat. No. SQH980XX
Length: 2.49m

Kit Contains

- Piece of Header Extrusion
- 91m Piece of Snap-In Filler for Door Pocket
- Vinyl for 8mm and 10mm Glass (not needed for 12mm)
- Pack of two BWB2 Brass Wall Mounting Brackets



Floor/Ceiling Mount Glass Clamp



Cat. No. CMC1XX

Specifications:

Glass Thickness Range: 8mm to 12mm Toughened Safety Glass

Construction: Solid Brass



Glass Fabrication Required: 12mm diameter hole

Includes: Gaskets and screws







Round Support Bar Series - 19 x 19 mm

| | |
|----------------------------------------------------------------------------------------------------------------------------------------------------------------------------------------------------------------------------------------------------------|--------------------------------------------------------------------------------------------------------------------------------------------------------------------------------------------------------------------------------------------------------------------------------------------------------------------------|
|  <p>Cat. No. S1XX Length: 1m</p> <p>Cat. No. S2XX Length: 1.3m</p> <p>Cat. No. S80 Length: 2.03m</p> |  <p>Cat. No. S8XX 90° Corner Bracket</p> |
|  <p>Cat. No. S3XX Wall Mount Fitting</p> |  <p>Cat. No. S9XX Vertical Support Bracket for 6mm to 8mm Glass</p> <p>Cat. No. S910XX Vertical Support Bracket for 10mm to 12mm Glass</p> |
|  <p>Cat. No. S4XX U-Bracket for 6mm to 8mm Glass</p> <p>Cat. No. S5XX U-Bracket for 10mm to 12mm Glass</p> |  <p>Cat. No. S12XX Wall Mount Fitting</p> |
|  <p>Cat. No. S6XX Movable U-Bracket for 6mm to 8mm Glass</p> <p>Cat. No. S7XX Movable U-Bracket for 10mm to 12mm Glass</p> |  <p>Cat. No. S13XX Glass Mount Fitting for 6mm to 12mm Glass</p> |
|  <p>Cat. No. S4VXX Swiveling Shower Stabilizer for 6mm to 8mm Glass</p> <p>Cat. No. S6VXX Swiveling Shower Stabilizer for 10mm to 12mm Glass</p> |  <p>Cat. No. SUPTCH "T" Junction Bracket</p> |
|  <p>Cat. No. S49XX Adjustable Wall Bracket for Use with Support Bars</p> | <p>Specifications: Glass Thickness Range: 6mm to 8mm, and 10mm to 12mm glass Construction: 19mm diameter tubular bar, solid brass fittings Includes: All required Mounting Hardware</p>  |

| | |
|--------------------------------------------------------------------------------------------------------------------------------------------------------------------------------------------------------------------------------|-----------------------------------------------------------------------------------------------------------------------------------------------------------------------------------------------------------------------------------------------------------------------------------------------------------------------------------------------------------------------------------------------------------------------------------------------------------------------------------------------------------------------------------------------------------------------------------------------------------------------------------------------------------------------------------------------------------------------------------------------------------------------------------------------------------------------------------------|
|  <p>Wall-to-Glass</p>  <p>Glass-to-Glass</p> | <p>Wall-to-Glass Support Bars</p> <p>Cat. No. SUP06XX For 6mm to 8mm glass, 1m length</p> <p>Cat. No. SUP10XX For 10mm to 12mm glass, 1m length</p> <p>Cat. No. SUP10XX51 For 10mm to 12mm glass, 1.3m length</p> <p>Glass-to-Glass Support Bars</p> <p>Cat. No. SUP26XX For 6mm to 8mm glass, 1m length</p> <p>Cat. No. SUP20XX For 10mm to 12mm glass, 1m length</p> <p>Cat. No. SUP20XX51 For 10mm to 12mm glass, 1.3m length</p> <p>Specifications: Glass Thickness: 6mm to 8mm, and 10mm to 12mm Construction: 19mm Diameter Tubular Brass Bar, Solid Brass Fittings Includes: All required Mounting Hardware</p>  |
|--------------------------------------------------------------------------------------------------------------------------------------------------------------------------------------------------------------------------------|-----------------------------------------------------------------------------------------------------------------------------------------------------------------------------------------------------------------------------------------------------------------------------------------------------------------------------------------------------------------------------------------------------------------------------------------------------------------------------------------------------------------------------------------------------------------------------------------------------------------------------------------------------------------------------------------------------------------------------------------------------------------------------------------------------------------------------------------|





Through-Glass Mounted Support Bar

The Through-Glass Mounted Support Bar creates a means of support that strengthens an enclosure's structural integrity. It may be used in place of a header in certain applications (call for details) and can be mounted to a wall, ceiling or glass-to-glass. Supplied Bar is 991mm long, requires a 16mm hole in the glass, and comes in finishes to match our Hinges and Pull Handles. All mounting hardware included.

| | |
|-----------------------------------------------------------------------------------------------------------------------------------------|------------------------------------------------------------------------------------------------------------------------------------------------------------------------------------------------------------------------------------------------------------------------------------------------------------------------------------------------------------------------------------------------------------------------------------------------------------------------------------------------------------------------------------------------------------------------------------------------------------------------------------------------------------------------------------------------------------------------------------------|
| <p>Ideal for use as a Shower Curtain Rod</p>  | <p>Cat. No. TUBE3472XX Thru-Glass to Wall Rod</p> <p>Requires additional fitting for wall attachment i.e. S3 or S12</p> <p>Specifications Construction: 19mm diameter stainless steel tubing Bar Length: 1.83m Glass Thickness: 6mm to 12mm Glass Fabrication Required: 12mm diameter hole Includes: 19mm diameter end cap on one end Polished Stainless (PS) shown, also available in Brushed Stainless (BS). For details please see the flip out chart at the rear of this brochure or visit crlaurence.co.uk</p>  |
|  | <p>Cat. No. SUP135XX Wall Mount</p> <p>Cat. No. SUP135G2GXX Glass-to-Glass Mount</p> <p>Specifications Construction: Solid brass Bar Length: 991mm Glass Thickness: 6mm to 12mm Glass Fabrication Required: 16mm diameter hole Includes: All required mounting hardware</p>  |

Mitred Support Bar Bracket

The Mitred Support Bar Wall Mount Bracket is designed to attach to the wall by slipping over a screw mounted stud that is secured into the wall. Perfect for an inline panel needing to be secured to an adjacent wall for stability. The Bracket comes in matching finishes, and fits any of our Fixed Panel Support Bars. Mitre of Bracket ensures flush fit against wall.

| | |
|---------------------------------------------------------------------------------------------------------------------------------------------------------------------------------------------------------------------------------------------------------------------------------------------------------------------------------------------------------------------------------------------------------------------------------------------------------|----------------------------------------------------------------------------------------------------------------------------------------------------------------------------------------------------------------------------|
|   <p>Cat. No. SBB45XX 45° Bracket</p>   <p>Cat. No. SBB22XX 22.5° Bracket</p> | <p>Specifications A great solution for inline enclosures requiring fixed panel support when a header is not desired Construction: Solid Brass Includes: Screw mounted stud</p> |
|---------------------------------------------------------------------------------------------------------------------------------------------------------------------------------------------------------------------------------------------------------------------------------------------------------------------------------------------------------------------------------------------------------------------------------------------------------|----------------------------------------------------------------------------------------------------------------------------------------------------------------------------------------------------------------------------|

4

U-Channels & Accessories for Showers

Our Regular and Deep U-Channels for Shower Door installations will secure fixed panels of Toughened Safety Glass to the wall, ceiling and floor.

In this section you will also find Accessories such as our large range of Door Knobs, Handles and Towel Bars that will add a touch of elegance to your bathroom. Their sleek and subtle appearance provides a minimalistic look.

To complete the door, you can also take a look at our extensive range of shower seals.



Handles

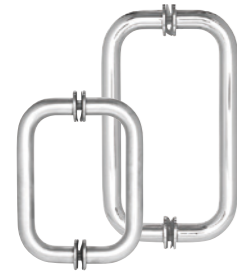

BM Series Back-to-Back Pull Handles

Cat. No. BM6X6XX
152mm size with metal washers

Cat. No. BM8X8XX
203mm size with metal washers



BM Series Back-to-Back Pull Handles

Cat. No. BMNW6X6XX
152mm size without metal washers

Cat. No. BMNW8X8XX
203mm size without metal washers



Crescent Style Back-to-Back Pull Handles

Cat. No. CSH6X6XX
152mm size without metal washers

Cat. No. CSH8X8XX
203mm size without metal washers



MT Series Back-to-Back Pull Handles

Cat. No. MT6X6XX
152mm size with metal washers

Cat. No. MT8X8XX
203mm size with metal washers



RM Series Flat Outside Surface/ Round Tubing Inside Back-to-Back Pull Handles

Cat. No. RM6X6XX
152mm size without metal washers

Cat. No. RM8X8XX
203mm size without metal washers



SQ Series Square Tubing Mitred Corner Back-to-Back Pull Handles

Cat. No. SQ6X6XX
152mm size without metal washers

Cat. No. SQ8X8XX
203mm size without metal washers

Specifications:

Glass Thickness: 6mm to 12mm Toughened Safety Glass

Construction: 19mm diameter brass tubing

Hole Diameter Required: 12mm

Mounting Holes: 152mm and 203mm Centre-to-Centre



Ladder Style Back-to-Back Pull Handle

Cat. No. LP6X6XX
152mm Handle, 19mm diameter

Cat. No. LP8X8XX
203mm Handle, 19mm diameter

Specifications:

Glass Thickness: 8mm to 12mm

Construction: Brass

Hole Diameter Required: 12mm

Mounting Holes: 152mm and 203mm
Centre-to-Centre



Ladder Pull Handles

Cat. No. EULP30019XX
300mm length, 19mm diameter,
200mm Centre-to-Centre

Cat. No. EULP40019XX
400mm length, 19mm diameter,
250mm Centre-to-Centre

Cat. No. EULP50019XX
500mm length, 19mm diameter,
350mm Centre-to-Centre

Cat. No. EULP60032XX
600mm length, 32mm diameter,
450mm Centre-to-Centre

Cat. No. EULP100032XX
1000mm length, 32mm diameter,
800mm Centre-to-Centre

Specifications:

Glass Thickness: 8mm to 19mm

Construction: 316 Stainless Steel

Hole Diameter Required: 12mm

Knobs



Cat. No. SDK106XX
Back-to-Back Contemporary Style

Glass Thickness: 6mm to 12mm
Hole Diameter Required: 12mm



Cat. No. SDK200XX
Single Sided Traditional Style

Cat. No. SDK100XX
Back-to-Back Traditional Style

Glass Thickness: 6mm to 12mm
Hole Diameter Required: 12mm



Cat. No. SDK206
Single Sided Square Style

Cat. No. SDK160XX
Back-to-Back Square Style

Glass Thickness: 6mm to 12mm
Hole Diameter Required: 12mm

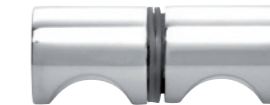

Cat. No. SDK140XX
Back-to-Back E-Z Grip Style

Glass Thickness: 6mm to 12mm
Hole Diameter Required: 12mm



Cat. No. SDK180XX
Back-to-Back Paddle Style

Glass Thickness: 6mm to 12mm
Hole Diameter Required: 12mm



Cat. No. SDK120XX
Back-to-Back Euro Style

Glass Thickness: 6mm to 12mm
Hole Diameter Required: 12mm

Altea range door knobs



Cat. No. ALTSK1XX
Single Sided Altea Series

Cat. No. ALTSK2XX
Back-to-Back Altea Series

Glass Thickness: 6mm to 10mm
Hole Diameter Required: 12mm

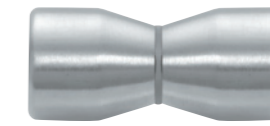

Cat. No. SDK109XX
Back-to-Back Bow Tie Style

Glass Thickness: 6mm to 12mm
Hole Diameter Required: 12mm



Cat. No. LAT001XX
180° Knob Latch

Cat. No. LAT135XX
135° Knob Latch

Glass Thickness: 8mm to 12mm
Hole Diameter Required: 22mm

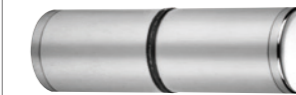

Cat. No. SDK212XX
Single Sided Cylinder Style

Cat. No. SDK112XX
Back-to-Back Cylinder Style

Glass Thickness: 6mm to 12mm
Hole Diameter Required: 12mm



Cat. No. EUSDK1XX
Back-to-Back Euro Style Chrome Plated

Cat. No. EUSDK2XX
Back-to-Back Euro Style Aluminium

Glass Thickness: 8mm to 10mm glass
Hole Diameter required: 10mm



Cat. No. SDK140CHEU
Back-to-back 40mm Diameter

Glass Thickness: 6mm to 12mm



Specifications:

Construction: Solid Brass, except EUSDK2 in Plated Aluminium

Towel Bars



| | |
|------------------------|-----------------|
| Cat. No. BM12XX | 305mm Towel Bar |
| Cat. No. BM18XX | 457mm Towel Bar |
| Cat. No. BM20XX | 508mm Towel Bar |
| Cat. No. BM22XX | 559mm Towel Bar |
| Cat. No. BM24XX | 610mm Towel Bar |
| Cat. No. BM26XX | 660mm Towel Bar |
| Cat. No. BM27XX | 686mm Towel Bar |
| Cat. No. BM28XX | 711mm Towel Bar |
| Cat. No. BM30XX | 762mm Towel Bar |



| | |
|--------------------------|-----------------|
| Cat. No. BMNW12XX | 305mm Towel Bar |
| Cat. No. BMNW18XX | 457mm Towel Bar |
| Cat. No. BMNW20XX | 508mm Towel Bar |
| Cat. No. BMNW22XX | 559mm Towel Bar |
| Cat. No. BMNW24XX | 610mm Towel Bar |
| Cat. No. BMNW26XX | 660mm Towel Bar |
| Cat. No. BMNW27XX | 686mm Towel Bar |
| Cat. No. BMNW28XX | 711mm Towel Bar |
| Cat. No. BMNW30XX | 762mm Towel Bar |



| | |
|-------------------------|-----------------|
| Cat. No. CSH18XX | 457mm Towel Bar |
| Cat. No. CSH24XX | 610mm Towel Bar |



| | |
|------------------------|-----------------|
| Cat. No. SQ18XX | 457mm Towel Bar |
| Cat. No. SQ24XX | 610mm Towel Bar |



| | |
|------------------------|-----------------|
| Cat. No. MT18XX | 457mm Towel Bar |
| Cat. No. MT24XX | 610mm Towel Bar |



| | |
|---------------------------|-----------------|
| Cat. No. BM12X12XX | 305mm Towel Bar |
| Cat. No. BM18X18XX | 457mm Towel Bar |
| Cat. No. BM24X24XX | 610mm Towel Bar |
| Cat. No. BM30X30XX | 762mm Towel Bar |



| | |
|-----------------------------|-----------------|
| Cat. No. BMNW12X12XX | 305mm Towel Bar |
| Cat. No. BMNW18X18XX | 457mm Towel Bar |
| Cat. No. BMNW24X24XX | 610mm Towel Bar |
| Cat. No. BMNW30X30XX | 762mm Towel Bar |

Specifications

Glass Thickness: 6mm to 12mm Toughened Safety Glass

Construction: 19mm Diameter Brass Tubing (1.5mm thick); 31.8mm Diameter Metal Washers

Hole Diameter Required: 12mm



Towel Bars



| | |
|---------------------------|-----------------|
| Cat. No. SQ18X18XX | 457mm Towel Bar |
| Cat. No. SQ24X24XX | 610mm Towel Bar |



| | |
|---------------------------|-----------------|
| Cat. No. MT18X18XX | 457mm Towel Bar |
| Cat. No. MT24X24XX | 610mm Towel Bar |



Pull Handle/ Towel Bar Combination

| | |
|---------------------------|------------------------------|
| Cat. No. BM6X12XX | 152mm Pull / 305mm Towel Bar |
| Cat. No. BM6X18XX | 152mm Pull / 457mm Towel Bar |
| Cat. No. BM6X22XX | 152mm Pull / 559mm Towel Bar |
| Cat. No. BM6X24XX | 152mm Pull / 610mm Towel Bar |
| Cat. No. BM8X18XX | 203mm Pull / 457mm Towel Bar |
| Cat. No. BM8X20XX | 203mm Pull / 508mm Towel Bar |
| Cat. No. BM8X22XX | 203mm Pull / 559mm Towel Bar |
| Cat. No. BM8X24XX | 203mm Pull / 610mm Towel Bar |
| Cat. No. BM12X24XX | 305mm Pull / 610mm Towel Bar |



Pull Handle/ Towel Bar Combination

| | |
|-----------------------------|------------------------------|
| Cat. No. BMNW6X12XX | 152mm Pull / 305mm Towel Bar |
| Cat. No. BMNW6X18XX | 152mm Pull / 457mm Towel Bar |
| Cat. No. BMNW6X22XX | 152mm Pull / 559mm Towel Bar |
| Cat. No. BMNW6X24XX | 152mm Pull / 610mm Towel Bar |
| Cat. No. BMNW8X18XX | 203mm Pull / 457mm Towel Bar |
| Cat. No. BMNW8X22XX | 203mm Pull / 559mm Towel Bar |
| Cat. No. BMNW8X24XX | 203mm Pull / 610mm Towel Bar |
| Cat. No. BMNW12X24XX | 305mm Pull / 610mm Towel Bar |



Door Knob/Towel Bar Combination

| | |
|--------------------------|----------------------------------------|
| Cat. No. TBCC18XX | 457mm Towel Bar with Contemporary Knob |
| Cat. No. TBCC24XX | 610mm Towel Bar With Contemporary Knob |



Door Knob/Towel Bar Combination

| | |
|--------------------------|---------------------------------------|
| Cat. No. TBCT18XX | 457mm Towel Bar With Traditional Knob |
| Cat. No. TBCT24XX | 610mm Towel Bar With Traditional Knob |

Specifications

Glass Thickness: 6mm to 12mm Toughened Safety Glass

Construction: 19mm Diameter Brass Tubing (1.5mm thick); 31.8mm Diameter Metal Washers

Hole Diameter Required: 12mm



Door Locks



Cat. No. 700CXX
Pivot Door Lock with Indicator



Cat. No. 703CXX
Sliding Door Lock with Indicator



Cat. No. 701CXX
Pivot Door Receiver



Cat. No. 704CXX
Sliding Door Receiver

Specifications:

Glass Thickness Range: 8mm to 12mm
Toughened Safety Glass

Glass Fabrication Required: Notch in glass

Includes: Gaskets and hex wrench



Cat. No. GE90SCAXX
Geneva Sliding Block Lock for RPS



Cat. No. P190SCAXX
Pinnacle Sliding Block Lock for RPS

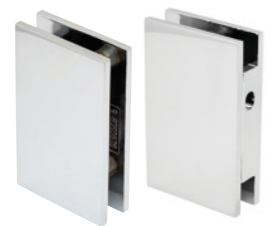

Cat. No. GE90SCBXX
Glass Mount Plate for RPS



Cat. No. P190SCBXX
Pinnacle Glass Mount Plate for RPS



Cat. No. GE90SC3XX
Geneva Stop Plate for RPS



Cat. No. P190SC3XX
Pinnacle Stop Plate for RPS

Specifications:

Glass Thickness: 10mm to 12mm
Toughened Safety Glass

Construction: Solid Brass

Glass Fabrication Required: Notch in glass

Includes: Gaskets, Phillips head & Allen head screws and a hex wrench



U-Channels

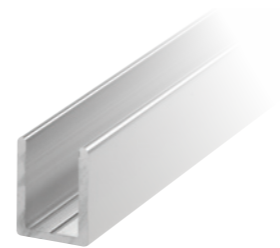

Aluminium Deep U-Channel

Specifications

- Length: 2.49m
- Deep Pocket Does Excellent Job of Securing Fixed Panels of Glass

- Wet Glazed with Clear Silicone to Secure Glass
- End Caps Offered to Conceal Ends of Channel
- Use Monolithic Toughened Glass

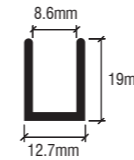

Cat. No. SDCD516XX
Length: 2.49m
Glass Thickness: 8mm

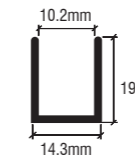

Cat. No. SDCD38XX
Length: 2.49m
Glass Thickness: 10mm

Cat. No. SDCD3812XX
Length: 3.65m
Glass Thickness: 10mm

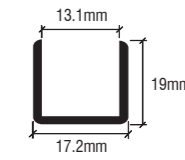

Cat. No. SDCD12XX
Length: 2.49m
Glass Thickness: 12mm

Cat. No. SDCD1212XX
Length: 3.65m
Glass Thickness: 12mm

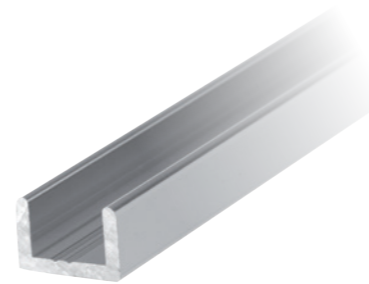

Aluminium Regular U-Channel

Specifications

- Length: 2.49m
- Wet Glazed with Clear Silicone to Secure Fixed Panels of Glass
- Lower Profile Allows Maximum Glass Exposure
- Use Monolithic Toughened Glass

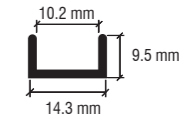

Cat. No. SDCR38XX
Glass Thickness: 10mm

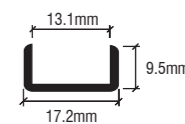

Cat. No. SDCR12XX
Glass Thickness: 12mm

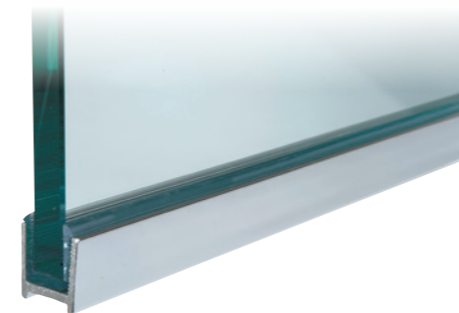

Aluminium Dry-Glaze U-Channel

Specifications

- Length: 2.49m
- Recess in Bottom Channel Hides Caulk Line
- Clear Vinyl's Secure Glass in Channel and Eliminate the Need for Messy Silicone
- Use Monolithic Toughened Glass

Cat. No. DUC516XX
Glass Thickness: 8mm

Cat. No. DUC38XX
Glass Thickness: 10mm

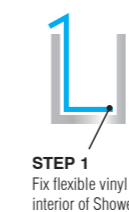
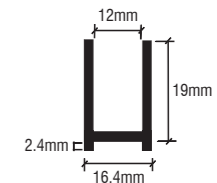

STEP 1
Fix flexible vinyl for interior of Shower



STEP 2
Fix rigid leg vinyl for exterior of shower

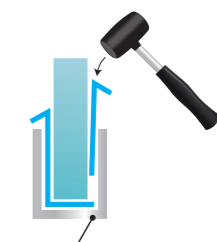

STEP 3
Complete by securing U-Channel

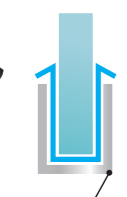

STEP 4
Done!

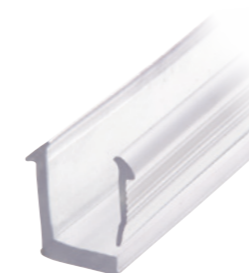

Cat. No. FV4DUC
Flexible Vinyl for DUC38 U-Channel
Glass thickness: 10mm

Cat. No. RV4DUC
Rigid Vinyl for DUC38 U-Channel
Glass thickness: 10mm

Cat. No. FV8DUC
Flexible Vinyl for DUC38 U-Channel
Glass thickness: 8mm

Cat. No. RV8DUC
Rigid Vinyl for DUC38 U-Channel
Glass thickness: 8mm



End Cap
Cat. No. SDCEC38XX
To fit channel CAT. NO. SDCD38

Cat. No. SDCEC12XX
To fit channel CAT. NO. SDCD12 / DUC38 / DUC516

U-Channels



Aluminium Recessed U-Channel

Specifications

- Length: 2.49m
- Ideal for Recessing Glass and Creating the 'All-Glass' Look
- Top of Channel Angled to Assist with Water Deflection
- Top Lip Helps Cover Edge of Tile

Cat. No. SDCF38XX

Glass Thickness: 10mm

Cat. No. SDCF12XX

Glass Thickness: 12mm

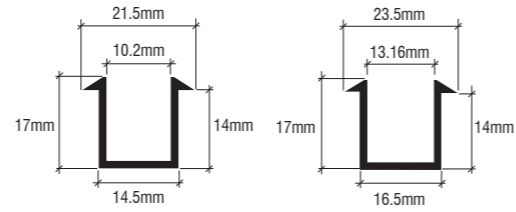

Aluminium U-Channel

Specifications

- Length: 2.5m (except chrome finish: 3m)
- Glass Thickness: 10mm to 12mm
- Wet Glazed with Clear Silicone to Secure Glass
- 2mm Wall Thickness

Cat. No. SDCD1515XX

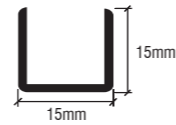

Aluminium U-Channel

Specifications

- Length: 2.5m (except chrome finish: 3m)
- Glass Thickness: 10mm to 12mm
- Wet Glazed with Clear Silicone to Secure Glass
- 2mm Wall Thickness

Cat. No. SDCD2020XX

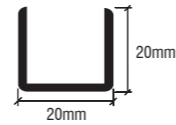

Aluminium U-Channel

Specifications

- Length: 2.5m (except chrome finish: 3m)
- Glass Thickness: 10mm to 12mm
- Wet Glazed with Clear Silicone to Secure Glass
- 2mm Wall Thickness

Cat. No. SDCD3020XX

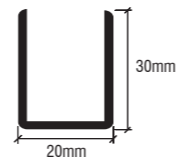

Aluminium U-Channel

Specifications

- Length: 2.5m (except chrome finish: 3m)
- Glass Thickness: 10mm to 12mm
- Wet Glazed with Clear Silicone to Secure Glass
- 2mm Wall Thickness

Cat. No. SDCD4020XX

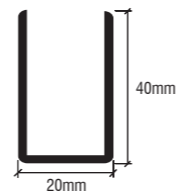

Shower Seals

Translucent Vinyl Bulb Seal

- Can be used on inswing and outswing doors

Cat. No. PCR8

- Length: 2.49m
- Glass Thickness: 8mm
- Suggested gap: 6mm to 8mm

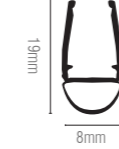

Cat. No. PCR10

- Length: 2.49m
- Glass Thickness: 10mm
- Suggested gap: 6mm to 8mm



Translucent Vinyl Bulb Seal

Cat. No. PCR8L

- Soft Vinyl Single Leg for Quieter Door Closure
- Length: 2.49m
- Glass Thickness: 8mm
- Suggested gap: 10mm

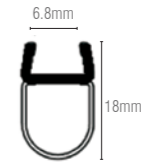

Polycarbonate Sweep

Cat. No. PCJ8

- Length: 2.49m
- Glass Thickness: 8mm
- Suggested gap: 5mm

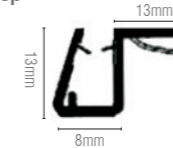

Cat. No. PCJ10

- Length: 2.49m
- Glass Thickness: 10mm
- Suggested gap: 5mm

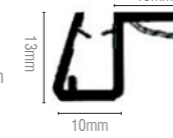

'Y' Jamb Seal with Soft leg

Cat. No. PCC8L

- Soft Vinyl Single Leg for Quieter Door Closure
- Length: 2.49m
- Glass Thickness: 6mm and 8mm
- Suggested gap: 10mm

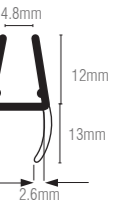

Translucent Vinyl Seal with Sealing Lip

Cat. No. P114WS

- Length: 2.49m
- Glass Thickness: 8mm
- Suggested gap: 4mm

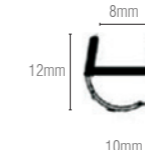

Cat. No. P124WS

- Length: 2.49m
- Glass Thickness: 10mm
- Suggested gap: 4mm

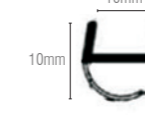

Clear Co-Extruded Bottom Wipe

Cat. No. P102WS

- Length: 2.49m
- Glass Thickness: 6mm and 8mm

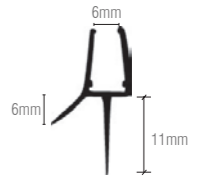

Dual Durometer PVC Seal

- Can be used as bottom sweep, or vertically on bi-fold doors
- Length: 2.49m
- Snap on application
- Can be used on inswing and outswing doors

Cat. No. P14WS

Glass Thickness: 6mm
Suggested gap: 5mm

X = 6mm
Y = 10mm
Z = 6mm

Cat. No. P880WS

Glass Thickness: 10mm
Suggested gap: 6mm

X = 10mm
Y = 14mm
Z = 6mm

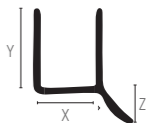

Cat. No. P770WS

Glass Thickness: 8mm
Suggested gap: 8mm

X = 8mm
Y = 12mm
Z = 6mm

Cat. No. P120WS

Glass Thickness: 12mm
Suggested gap: 6mm

X = 12mm
Y = 15mm
Z = 6mm



Co-Extruded Bottom Wipe with Drip Rail

- Length: 2.49m
- Our most popular bottom sweep
- Snaps on bottom of door
- 45° drip rail assists in deflecting water back into the enclosure
- Use monolithic toughened glass

Cat. No. P914WS

Glass Thickness: 6mm
Suggested gap: 8mm

X = 6mm
Y = 16mm

Cat. No. P990WS

Glass Thickness: 10mm
Suggested gap: 8mm

X = 12mm
Y = 19mm

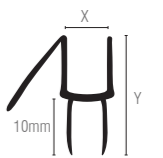

Cat. No. P956WS

Glass Thickness: 8mm
Suggested gap: 8mm

X = 8mm
Y = 16mm

Cat. No. P912WS

Glass Thickness: 12mm
Suggested gap: 8mm

X = 12mm
Y = 19mm



Shower Seals



Bubble Wipe with Drip Rail

Cat. No. P141WS

- Length: 2.49m
- Glass Thickness: 6mm to 8mm
- Can be used on inswing and outswing doors
- Suggested gap: 12mm

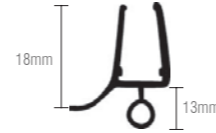

Translucent Silicone Bulb Seal

Cat. No. S1LB

- Length: 2.49m
- Glass Thickness: 8mm
- Can be used on inswing and outswing doors
- Close Gaps from 1.6 to 5mm
- Adheres using silicone only (not very hi-bond tape)
- Suggested gap: 5mm

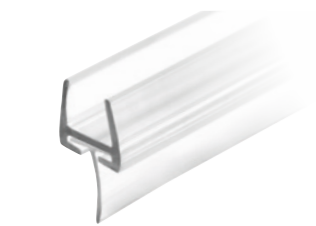

Clear Bottom Rail With Translucent Wipe

- Length: 2.49m
- Vinyl insert included
- Snaps on bottom of door
- Includes insert slot without SDTW 'T' wipe

Cat. No. P450BR

Glass Thickness: 8mm
Suggested gap: 12mm
'X': 8mm

Cat. No. P500BR

Glass Thickness: 10mm
Suggested gap: 10mm
'X': 10mm

Cat. No. P660BR

Glass Thickness: 12mm
Suggested gap: 12mm
'X': 12mm

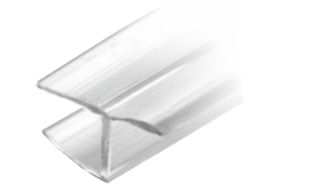
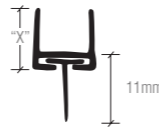

"H" Jamb With Soft Leg

- Length: 2.49m
- Soft vinyl single leg for quieter door closure
- Snaps onto fixed panel
- For glass-to-glass applications

Cat. No. PCC8

Glass Thickness: 8mm
Suggested gap: 4mm to 6mm

'X': 19mm
'Y': 11mm

Cat. No. PCC10

Glass Thickness: 10mm
Suggested gap: 4mm to 6mm

'X': 21mm
'Y': 12mm

Cat. No. PCC12

Glass Thickness: 12mm
Suggested gap: 4mm to 6mm

'X': 21mm
'Y': 12mm

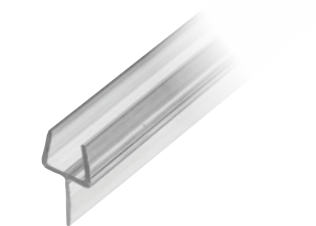

One Piece Bottom Rail with Clear Wipe

One-piece bottom rail with clear wipe for 10 to 12mm glass

- Single-piece bottom sweep
- Snaps onto door bottom to achieve a seal
- Length: 2.49m

Cat. No. P501BR

Glass Thickness: 10mm
Suggested gap: 11mm

X = 11mm
Y = 11mm

Cat. No. P661BR

Glass Thickness: 12mm
Suggested gap: 11mm

X = 12mm
Y = 11mm

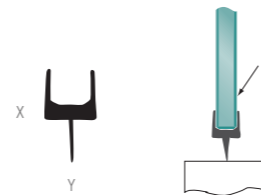

Shower Seals

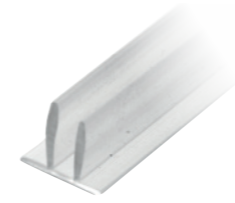

Translucent Vinyl Double Fin Seal

- Length: 2.49m
- Can Be Used for Inswing or Outswing Doors
- Suggested Gap: 6mm
- Glass Thickness: 8mm

Cat. No. SDTDF

Without Tape

- Pre-applied VHB tape for easy installation
- Labour savings due to pre-application of tape

Cat. No. SDTDF2

With Pre-Applied Tape

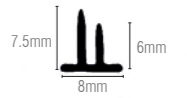

Translucent Vinyl 'L' Seal

- Length: 2.49m
- Can be used on outswing doors only
- Suggested gap: 4mm to 6mm

Cat. No. SDTL

Without Tape

- Pre-applied VHB tape for easy installation
- Labour savings due to pre-application of tape

Cat. No. SDTLT2

With Pre-Applied Tape

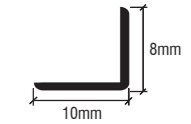

Translucent Vinyl Edge 'V' Seal

- Can be used only on doors swinging one way
- Length: 2.49m
- Glass Thickness: 8mm
- Suggested Gap: 4mm

Cat. No. SDTS

Without Tape

- Pre-applied high-bond tape for easy installation
- Labour savings due to pre-application of tape

Cat. No. SDTST2

With Pre-Applied Tape

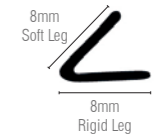

Translucent Vinyl Edge 'V' Seal

- Length: 2.49m
- Can Be Used On in or Out-Swinging Doors
- Suggested Gap: 10mm
- Glass Thickness: 8mm

Cat. No. SDTW

Without Tape

- Pre-applied tape for easy installation
- Labour savings due to pre-application of tape

Cat. No. SDTWT2

With Pre-Applied Tape

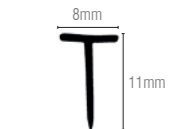

Translucent Vinyl Bulb Seal

- Length: 2.49m
- Suggested Gap: 5mm

Cat. No. SDTB

Without Tape

- Pre-applied VHB tape for easy installation
- Labour savings due to pre-application of tape

Cat. No. SDTBT2

With Pre-Applied Tape



Shower Seals

Clear 90° Magnetic Profile

- Length: 2.49m
- Provides positive door closure
- Mix and match configurations to achieve desired result
- Made of co-extruded plastic with soft magnetic receiver
- For use with other magnetic profiles

Cat. No. PMC8

Glass thickness: 6mm to 8mm
6mm glass - Suggested gap: 17mm
8mm glass - Suggested gap: 20mm

Cat. No. PMC10

Glass thickness: 10mm to 12mm
10mm glass - Suggested gap: 17mm
12mm glass - Suggested gap: 20mm



Clear 45° LH Magnetic Profile

- Length: 2.49m
- Provides positive door closure
- Mix and match configurations to achieve desired result
- Made of co-extruded plastic with soft magnetic receiver
- For use with other magnetic profiles
- For information on suggested gap, contact our Technical Department

Cat. No. PMA8

Glass thickness: 6mm to 8mm

Cat. No. PMA10

Glass thickness: 10mm to 12mm



Clear 45° RH Magnetic Profile

- Length: 2.49m
- Provides positive door closure
- Mix and match configurations to achieve desired result
- Made of co-extruded plastic with soft magnetic receiver
- For use with other magnetic profiles
- For information on suggested gap, contact our Technical Department

Cat. No. PMB8

Glass thickness: 6mm to 8mm

Cat. No. PMB10

Glass thickness: 10mm to 12mm



For 6mm to 8mm thick glass

| Angle | Profiles Required | Notes |
|-------|-------------------|-------------------------------------------|
| 180° | PMA8 + PMA8 | Door swings in one direction only |
| 180° | PMC8 + PMC8 | Door swings in both directions |
| 135° | PMA8 + PMC8 | Door swings out only |
| 90° | PMA8 + PMB8 | Reverse for polarity-door swings out only |

For 10mm to 12mm thick glass

| Angle | Profiles Required | Notes |
|-------|-------------------|-------------------------------------------|
| 180° | PMA10 + PMA10 | Door swings in one direction only |
| 180° | PMC10 + PMC10 | Door swings in both directions |
| 135° | PMA10 + PMC10 | Door swings out only |
| 90° | PMA10 + PMB10 | Reverse for polarity-door swings out only |

Notes

Colour range*

All CRL Frameless Shower Door products are available in a variety of beautiful stock finish to enhance the décor of the surrounding environments. Add the chosen colour code to a Cat. No. to complete your product code.

Note: Not all Finishes are available for every product, please call or consult crlaurence.co.uk for product specific colour options.

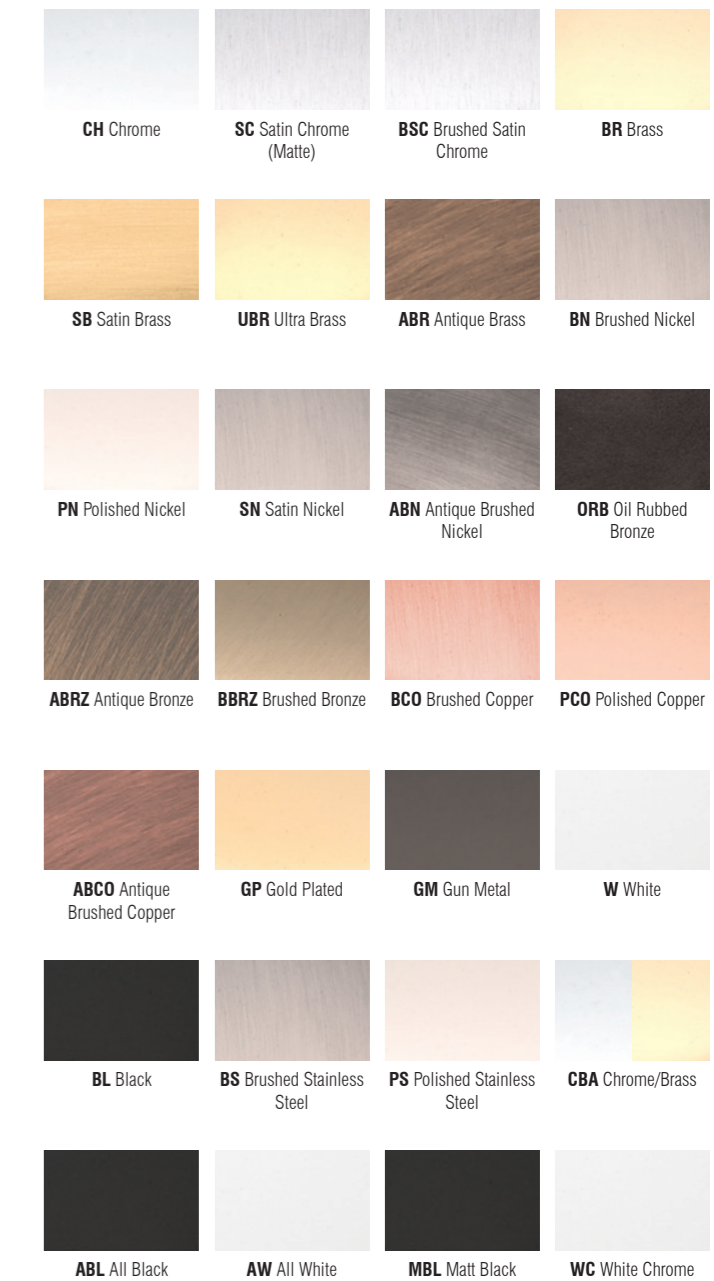

* The finishes shown are as close as possible to the actual item. Some images might look a little different when compared to the actual product.

Colour range

See our range of colour
finishes overleaf. Keep the flap
open for easy reference.

Call FREE on 00 800 0421 6144

Fax FREE on 00 800 0262 3299



Manchester

Charles Babbage Avenue
Kingsway Business Park,
Rochdale, OL16 4NW, England
Tel: +44 (0) 1706 863 600
Fax: +44 (0) 1706 869 860
crlaurence.co.uk



Stuttgart

Boschstrasse 7
D-74360 Ilsfeld
Germany
Tel: +49 (0) 7062 915 93 15
Fax: +49 (0) 7062 915 93 16
crl.eu



Copenhagen

Stamholmen 70 Unit B,
DK-2650 Hvidovre
Denmark
Tel: +45 36 72 09 00
Fax: +45 36 70 33 35
crlaurence.dk



France

Boschstrasse 7
D-74360 Ilsfeld
Germany
Tel: +49 (0) 7062 915 93 12
Fax: +49 (0) 7062 915 93 16
crlaurence.fr